

DIY Concrete Sleeper

adbriMASONRY

an ADBRI company

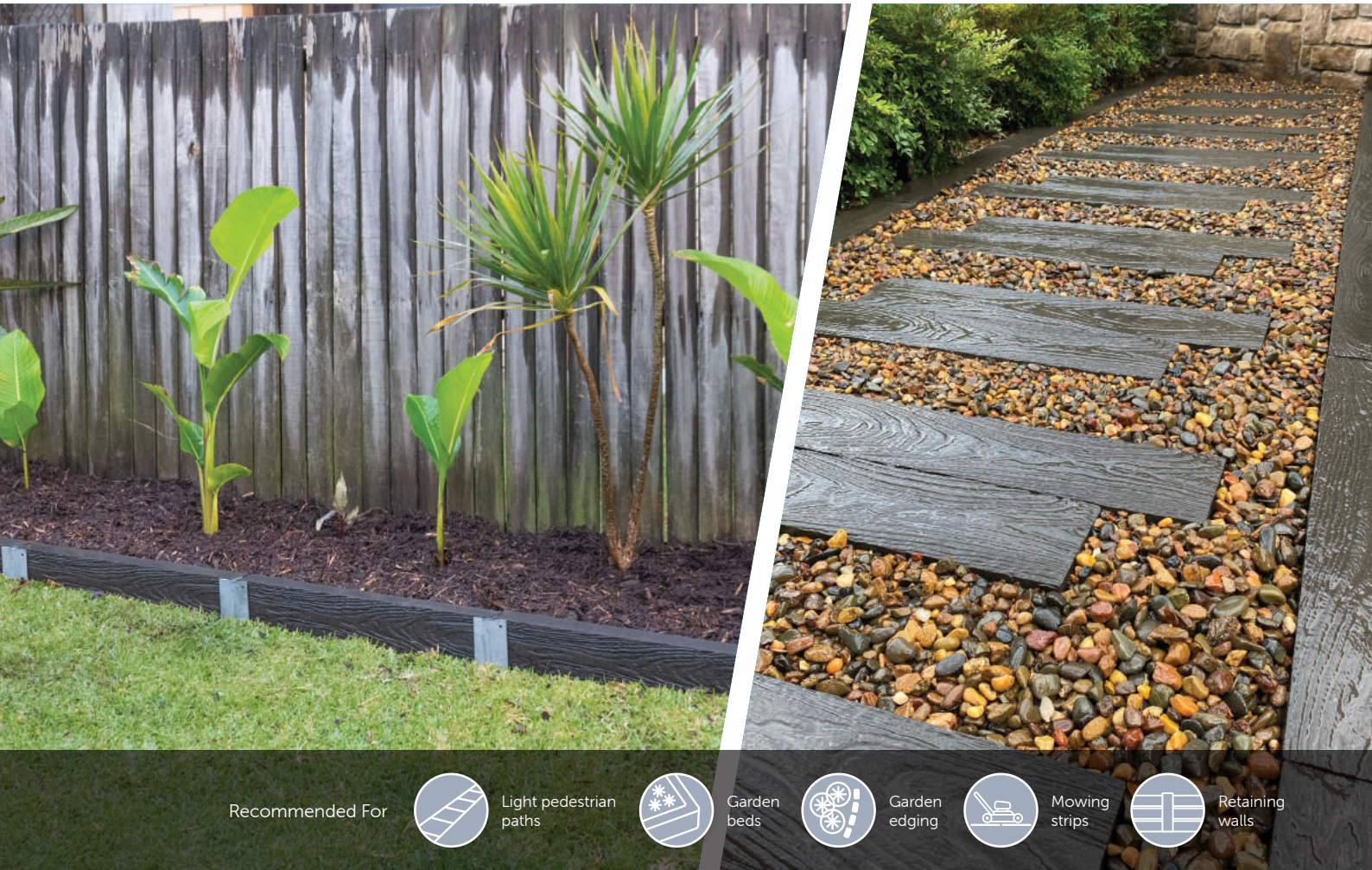

DIY Concrete Sleeper

The DIY Concrete Sleeper is a DIY friendly low height garden wall, perfect for edging, planter boxes, mowing strips, low height retaining walls and light pedestrian paths.



AUSTRALIAN MADE **QUALITY**
MASONRY **CONCRETE PRODUCTS**
BUILT TO LAST.

COLOUR OPTIONS

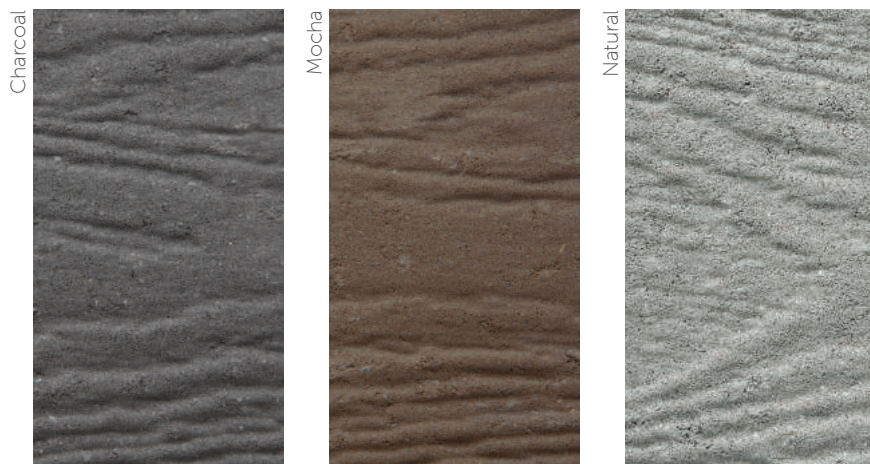

FEATURES

- ✓ Build garden walls to 750mm high
- ✓ Use the sleeper as a low-cost post
- ✓ Quick and easy to build
- ✓ Light pedestrian paths

Due to natural variations in aggregates, colour tones may vary from batch to batch. Whilst these swatches provide a good indication of the products colour, you should always sight product samples before use.



AVAILABLE SIZE

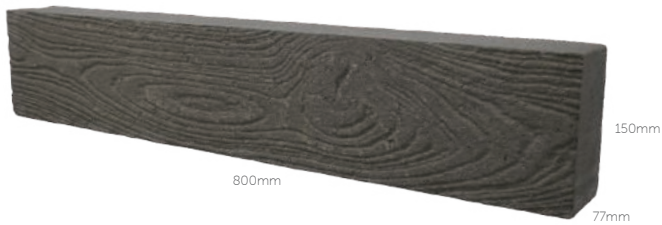

DIY Concrete Sleeper
8.33 units per m²

COLOUR OPTIONS

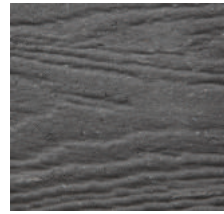

Charcoal

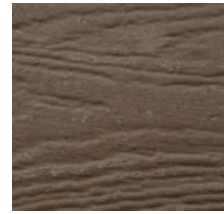

Mocha

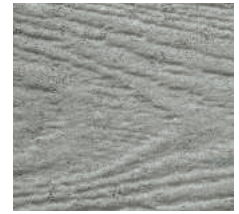

Natural

TECHNICAL INFORMATION

Range	Size (mm)	No. per m ²	Weight (kg)	No. per pallet	Colours
DIY Concrete Sleeper	800 x 150 x 77	8.33	20	56	Charcoal Mocha Natural

RETAINING WALLS

- Using I beams: build up to 5 courses high (750mm max)
- Using sleeper as post: build up to 400mm high
(2 courses, or 3 if bottom course is buried 50mm)

DIY Concrete Sleeper as post - mark out wall and spacing of posts. Prepare post hole ensuring depth equals height of the wall above ground (max building 400mm high, post hole must be 400mm deep). Embed post vertically, fill hole with concrete and check for level. Once post is embedded and firm, build sleeper wall behind posts. Apply landscape adhesive to the back of sleeper posts to form contact with sleepers when installed.

PAVING

DIY Concrete Sleeper can be used for step stone paths when laid on mudmix, or for paving when laid on concrete base.

All dimensions are in millimetres. Metal posts / I beams are sold separately via 3rd party retailers. Retaining walls should be built with 20mm aggregate and socked subsoil drain behind the wall

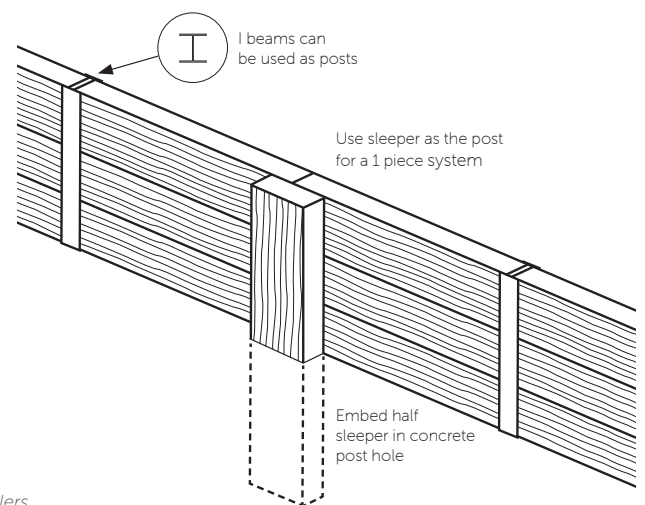

BRICKS



BESSER® BLOCKS



PAVERS



RETAINING WALLS



1300 365 565 | adbrimasonry.com.au

ABN: 31 009 687 521 | ISSUE DATE: 08/2022

adbriMASONRY
an ADBRI company